

Model 5915-X
Low-Pass Risetime Filters

- 52 MB/s to 12.5 GB/s
- SONET, SDH, Fiber Channel, Gigabit Ethernet
- Z-Matched, No Reflection - No Echo
- Risetime 35 ps to 10 ns



The Model 5915-X Low-Pass Risetime Filters are designed for OEM use in high speed digital networks and telecom systems. Filters are available for all SONET, SDH, Fiber Channel, and Gigabit Ethernet data rates. In addition, PSPL can build custom-frequency filters for any frequency from 35 MHz to 10 GHz. The -3 dB bandwidth of the standard filters is $0.75 * \text{Bit Rate}$. These filters are a PSPL proprietary, absorption filter design that has attenuation and group delay frequency responses similar to those of the **Bessel-Thomson** filter. Bessel-Thomson filters filter by reflection and thus can cause increased bit error rates and eye diagram closure due to multiple reflections. By contrast, the PSPL filters filter by absorption. They have excellent impedance matches and very good return losses, both within and above the filter pass band. For additional details on these filters, see PSPL application note, AN-7a, "Low-Pass Risetime Filters for Time Domain Applications." When ordering, specify the desired -3 dB bandwidth frequency or 10%-90% risetime. The 5915-X is the suggested replacement for PSPL's discontinued design 5905 and 5910 filters.

Return Loss	>15 dB at f_0 , typical	Max Voltage	50 V DC
Risetime	$Tr \approx 0.35/f_0$	Insertion Loss	< 0.02 dB at DC
Bandwidth (-3 dB), f_0	35 MHz to 10 GHz, specify on order	Impedance	50 Ω
f_0 Tolerance at 23 C	2%, 5% $f > 3$ GHz	Connectors	SMA (refer to ordering information on last page)
Max. Power	23 dBm at f_0	Temperature	-25 C to + 90 C
Max Current	1 A	Warranty	One year. See Terms and Conditions of Sale for details

SONET	SDH	Bit Rate	Filter (-3 dB)
OC-1	STM-0	51.84 MB/s	38.9 MHz
OC-3	STM-1	155.52 MB/s	117 MHz
OC-12	STM-4	622.08 MB/s	467 MHz
OC-24	STM-8	1244.16 MB/s	933 MHz
OC-48	STM-16	2488.32 MB/s	1.87 GHz
OC-192	STM-64	9953.28 MB/s	7.46 GHz
Fiber Channel		1062.5 MB/s	797 MHz
Gigabit Ethernet		1250 MB/s	938 MHz

Gigabit Ethernet Filter
f(-3 dB) = 938 MHz

SONET OC-48 Filter
f(-3 dB) = 1.87 GHz

SONET OC-192 Filter
f(-3 dB) = 7.46 GHz

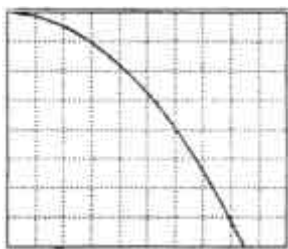
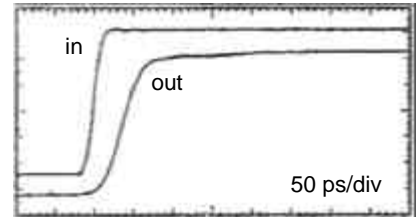
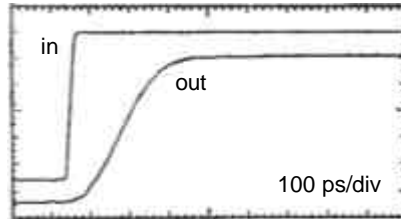
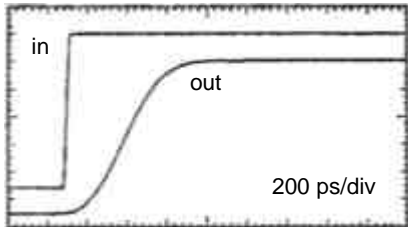

2 dB/div and 250 MHz/div
 S_{21} Insertion Loss

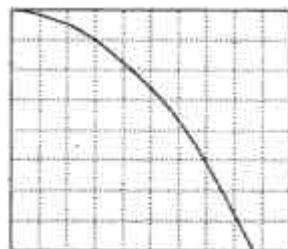

2 dB/div and 500 MHz/div
 S_{21} Insertion Loss

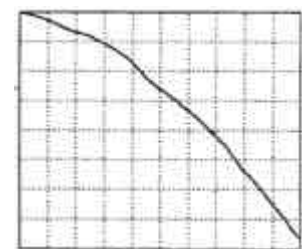

2 dB/div and 2 GHz/div
 S_{21} Insertion Loss

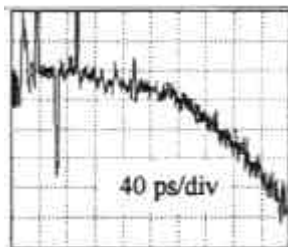

40 ps/div and 250 MHz/div
 S_{21} Group Delay

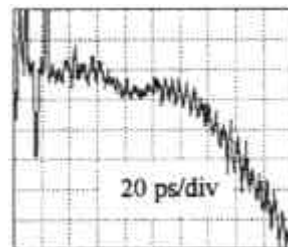

20 ps/div and 500 MHz/div
 S_{21} Group Delay

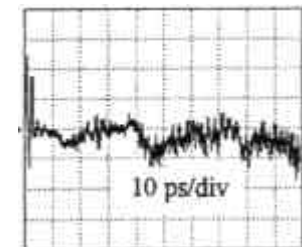

10 ps/div and 2 GHz/div
 S_{21} Group Delay

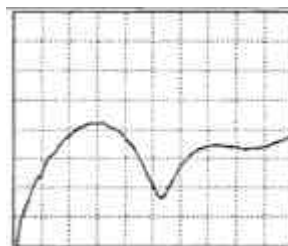

5 dB/div and 250 MHz/div
 S_{11} Return Loss

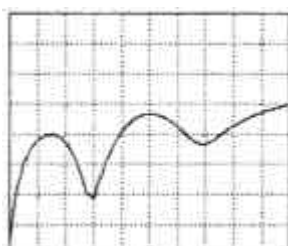

5 dB/div and 500 MHz/div
 S_{11} Return Loss

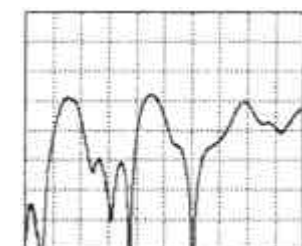

5 dB/div and 2 GHz/div
 S_{11} Return Loss

Frequency responses measured using a Wiltron 37369A, 40 MHz to 40 GHz vector network analyzer. 20 ps risetime, pulse step responses measured using a PSPL Model 4015C 15 ps Pulse Generator and an HP-54124A, 50 GHz oscilloscope.

5915-X Mechanical Drawing

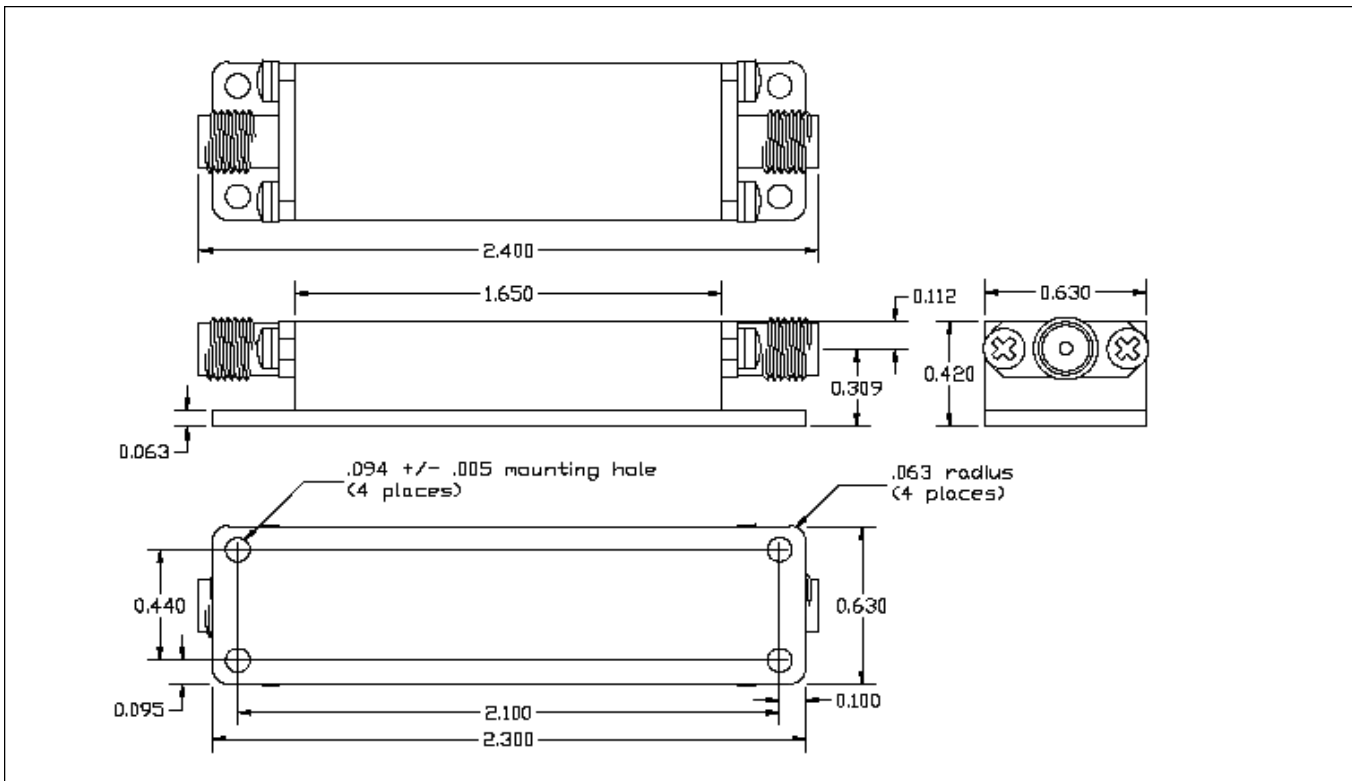

Ordering Information

Model Number	Description
5915-100-XMHZ	Low-Pass Filter, X = -3 dB frequency between 35 and 999 MHz with input jack — output jack
5915-100-XGHZ	Low-Pass Filter, X = -3 dB frequency between 1.0 and 10.0 GHz with input jack — output jack
5915-100-XNS	Risetime Filter, X = 10% - 90% risetime between 1.0 and 10.0 ns with input jack — output jack
5915-100-XPS	Risetime Filter, X = 10% - 90% risetime between 35 and 999 ps with input jack — output jack
5915-110-XMHZ	Low-Pass Filter, X = -3 dB frequency between 35 and 999 MHz with input jack — output plug
5915-110-XGHZ	Low-Pass Filter, X = -3 dB frequency between 1.0 and 10.0 GHz with input jack — output plug
5915-110-XNS	Risetime Filter, X = 10% - 90% risetime between 1.0 and 10.0 ns with input jack — output plug
5915-110-XPS	Risetime Filter, X = 10% - 90% risetime between 35 and 999 ps with input jack — output plug

Other connector combinations are available on request.